

**NATURAL SCIENCES  
ADMISSIONS ASSESSMENT****Specimen Paper****80 minutes****SECTION 1****INSTRUCTIONS TO CANDIDATES**

**Please read these instructions carefully, but do not open this question paper until you are told that you may do so.** This paper is Section 1 of 2.

A separate answer sheet is provided for this paper. Please check you have one. You also require a soft pencil and an eraser.

Please complete the answer sheet with your candidate number, centre number, date of birth, and name.

At the end of 80 minutes, your supervisor will collect this question paper and answer sheet before giving out Section 2.

This paper contains **five** parts: **A, B, C, D,** and **E**.

**All** candidates should complete **Part A** Mathematics.

**All** candidates should then complete **two** further parts chosen from:

<b>Part B</b>	Physics
<b>Part C</b>	Chemistry
<b>Part D</b>	Biology
<b>Part E</b>	Advanced Mathematics and Advanced Physics

Each part has 18 multiple-choice questions. There are no penalties for incorrect responses, only marks for correct answers, so you should attempt all of the questions in your **three** parts. Each question is worth one mark.

For each question, choose the **one** option you consider correct and record your choice on the separate answer sheet. If you make a mistake, erase thoroughly and try again.

You **must** complete the answer sheet within the time limit.

You can use the question paper for rough working, but **no extra paper** is allowed. Only your responses on the answer sheet will be marked.

Dictionaries and calculators are NOT permitted.

**Please wait to be told you may begin before turning this page.**

*This question paper consists of 64 printed pages and 8 blank pages.*

**BLANK PAGE**

**Paper content**

PART A Mathematics .....	5
PART B Physics .....	17
PART C Chemistry .....	31
PART D Biology .....	43
PART E Advanced Mathematics and Advanced Physics.....	61

**BLANK PAGE**

**PART A Mathematics**

PART A Mathematics

- 1 A square piece of metal has a semicircular piece cut out of it as shown. The area of the remaining metal is  $100 \text{ cm}^2$ .

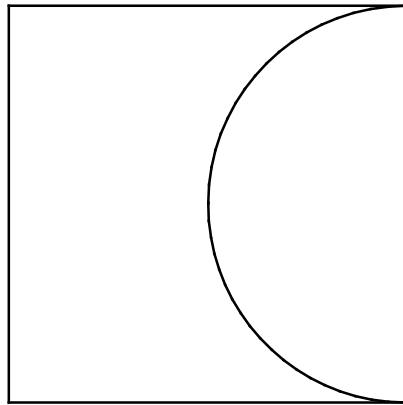

[diagram not to scale]

Which one of the following is a correct expression for the length of the side of the square in centimetres?

- A  $20\sqrt{\frac{2}{8-\pi}}$
- B  $10\sqrt{\frac{2}{4-\pi}}$
- C  $20\sqrt{\frac{2}{8+\pi}}$
- D  $10\sqrt{\frac{1}{8-\pi}}$
- E  $20\sqrt{\frac{1}{4-\pi}}$
- 2 In a right-angled triangle PQR the hypotenuse is the side PR.

The length of side PQ is 20 cm and the ratio RQ : PQ is 1 : 2

What is the length of the perpendicular from the hypotenuse to the point Q?

- A  $8\sqrt{5}$  cm
- B  $10\sqrt{2}$  cm
- C  $2\sqrt{5}$  cm
- D  $5\sqrt{2}$  cm
- E  $4\sqrt{5}$  cm

- 3 A cube has sides of unit length. What is the length of a line joining a vertex to the midpoint of one of the opposite faces (the dashed line in the diagram below)?

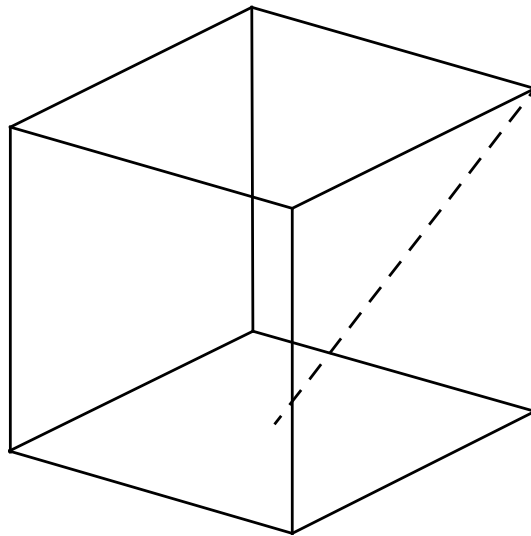

[diagram not to scale]

- A  $\sqrt{\frac{3}{2}}$   
B  $\sqrt{2}$   
C  $\sqrt{\frac{5}{2}}$   
D  $\sqrt{3}$   
E  $\sqrt{5}$
- 4 If you look at a clock and the time is 9:45, what is the angle between the hour and the minute hands?
- A 00  
B  $7.5^\circ$   
C  $15^\circ$   
D  $22.5^\circ$   
E  $30^\circ$

PART A Mathematics

- 5 The right-angled triangle shown has horizontal and vertical sides measuring  $(4 + \sqrt{2})$  cm and  $(2 - \sqrt{2})$  cm respectively.

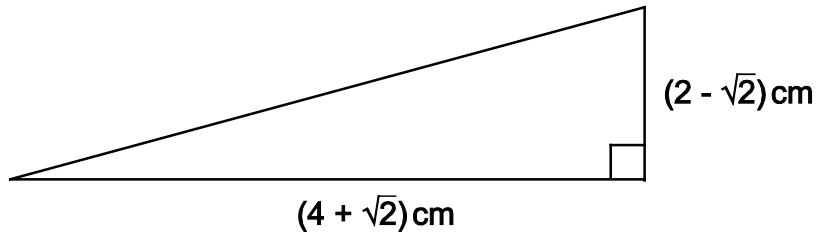

[diagram not to scale]

Calculate the area of the triangle.

- A  $(5 + 3\sqrt{2})$  cm<sup>2</sup>  
B  $(3 - \sqrt{2})$  cm<sup>2</sup>  
C  $(3 + 3\sqrt{2})$  cm<sup>2</sup>  
D  $(5 - \sqrt{2})$  cm<sup>2</sup>
- 6 A solid sphere of radius  $r$  fits inside a hollow cylinder. The cylinder has the same internal diameter and length as the diameter of the sphere.

The volume of a sphere is  $\frac{4}{3}\pi r^3$ , where  $r$  is the radius of the sphere.

What fraction of the space inside the cylinder is taken up by the sphere?

- A  $\frac{1}{4}$   
B  $\frac{1}{3}$   
C  $\frac{1}{2}$   
D  $\frac{2}{3}$   
E  $\frac{3}{4}$



7 Which of the expressions below has the largest value for  $0 < x < 1$ ?

- A  $\frac{1}{x}$
- B  $x^2$
- C  $\frac{1}{(1+x)}$
- D  $\frac{1}{\sqrt{x}}$
- E  $\sqrt{x}$

8 A shape is formed by drawing a triangle ABC inside the triangle ADE.

BC is parallel to DE.

AB = 4 cm    BC =  $x$  cm    DE =  $x+3$  cm    DB =  $x-4$  cm

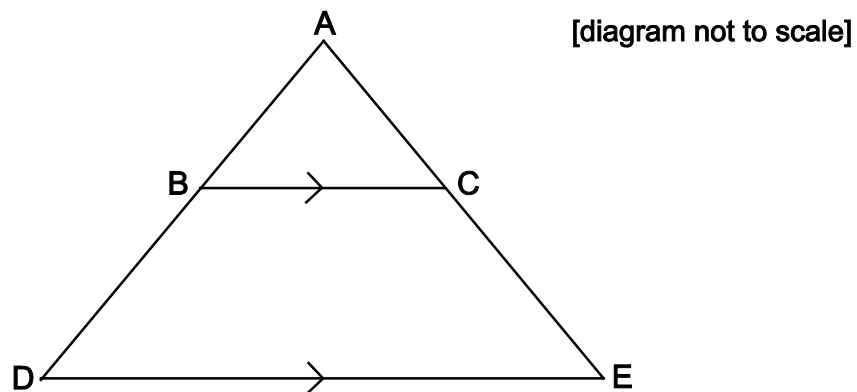

Calculate the length of DE.

- A 5 cm
- B 7 cm
- C 9 cm
- D  $4 + 2\sqrt{7}$  cm
- E  $7 + 2\sqrt{7}$  cm

PART A Mathematics

- 9 Two variables are connected by the relation:  $P \propto \frac{1}{Q^2}$

$Q$  is increased by 40%.

To the nearest percent, describe the change in  $P$  in percentage terms.

- A 29% decrease
- B 44% decrease
- C 49% decrease
- D 51% decrease
- E 80% decrease
- F 96% decrease

- 10 Three variables  $x$ ,  $y$  and  $z$  are known to be related to each other in the following ways:

$x$  is directly proportional to the square of  $z$ .

$y$  is inversely proportional to the cube of  $z$ .

Which of the following correctly describes the relationship between  $x$  and  $y$ ?

- A The square of  $x$  is directly proportional to the cube of  $y$ .
- B The square of  $x$  is inversely proportional to the cube of  $y$ .
- C The cube of  $x$  is directly proportional to the square of  $y$ .
- D The cube of  $x$  is inversely proportional to the square of  $y$ .
- E  $x$  is directly proportional to  $y^6$ .

- 11 In the triangle PQR shown below:

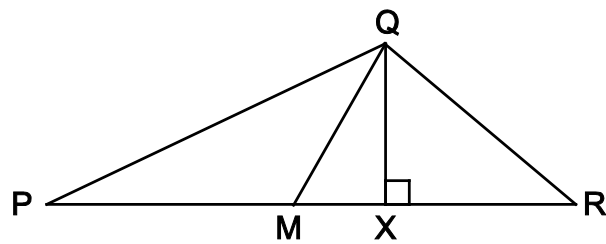

[diagram not to scale]

X lies on PR

$\angle QXR$  is  $90^\circ$

$$\frac{QX}{PX} = \frac{1}{6}$$

$$\frac{QX}{XR} = \frac{2}{3}$$

M is the midpoint of PR.

What is  $\frac{QX}{MX}$  ?

**A**  $\frac{1}{9}$

**B**  $\frac{5}{12}$

**C**  $\frac{4}{9}$

**D**  $\frac{1}{2}$

**E**  $\frac{5}{6}$

- 12 Solve the inequality  $x^2 \geq 8 - 2x$

**A**  $x \geq 4$

**B**  $x \leq 2$  and  $x \geq -4$

**C**  $x \geq -2$  and  $x \leq 4$

**D**  $x \geq 2$  or  $x \leq -4$

PART A Mathematics

- 13** The total surface area of a cylinder, measured in square centimetres, is numerically the same as its volume, measured in cubic centimetres.

The radius of the cylinder is  $r$  cm, the height is  $h$  cm.

Express  $h$  in terms of  $r$ .

**A**  $h = \frac{2r}{r-2}$

**B**  $h = \frac{2r}{r+2}$

**C**  $h = r + 2$

**D**  $h = r - 2$

**E**  $h = 2r(r-2)$

- 14** How many different integers,  $n$ , are there such that the difference between  $2\sqrt{n}$  and 7 is less than 1?

**A** 0

**B** 2

**C** 4

**D** 6

**E** 8

- 15** The square PQRS is positioned so that its vertices are at the points with coordinates: (1, 1), (-1, 1), (-1, -1) and (1, -1).

The square is rotated clockwise through  $90^\circ$  about the origin and then reflected in the line  $y = x$

Which transformation will return the square to its original orientation?

- A** A reflection in the  $x$ -axis.  
**B** A reflection in the  $y$ -axis.  
**C** A reflection in the line  $y = -x$   
**D** A rotation of  $90^\circ$  clockwise about the origin.  
**E** A rotation of  $90^\circ$  anticlockwise about the origin.
- 16** A design is set up by joining the points which are one third of the way along the sides of a square. This forms a second square as shown.

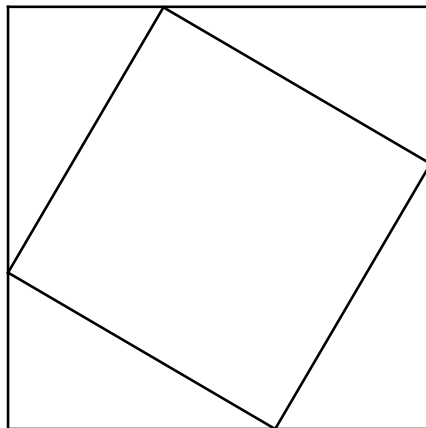

[diagram not to scale]

This process is repeated.

Calculate the area of the fourth square as a fraction of the original square.

- A**  $\frac{1}{27}$   
**B**  $\frac{5\sqrt{5}}{81}$   
**C**  $\frac{125}{729}$   
**D**  $\frac{25}{81}$   
**E**  $\frac{5\sqrt{5}}{27}$

PART A Mathematics

- 17 The equation connects the variables  $M$ ,  $x$ ,  $y$ ,  $z$ ,  $P$  and  $Q$ .

$$M = \frac{(x+y)^2 z}{P} Q$$

The following changes are made:

$x$  and  $y$  are both increased by 50%

$z$  is decreased by 20%

$P$  is doubled and  $Q$  remains the same.

What is the resulting percentage change in  $M$ ?

- A 2.5% decrease
  - B 2.5% increase
  - C 10% decrease
  - D 10% increase
  - E 20% decrease
  - F 20% increase
- 18 I have two six-sided dice, each with faces numbered from 1 to 6. One of the dice is fair, but the other is not; it will land on numbers 1 to 5 with equal probability, but lands on 6 with a different probability.

When I roll the dice the probability that I get a total of 12 is  $\frac{1}{18}$ .

What is the probability that I get a total of 2 when I roll the dice?

- A  $\frac{1}{72}$
- B  $\frac{1}{45}$
- C  $\frac{1}{36}$
- D  $\frac{1}{18}$
- E  $\frac{1}{9}$

**BLANK PAGE**

**BLANK PAGE**



**PART B Physics**

PART B Physics

- 19 Shortly after opening her parachute, a free-fall parachutist of mass 60 kg (including equipment) experiences the forces shown in the diagram.

drag (air resistance) = 900 N

[diagram not to scale]

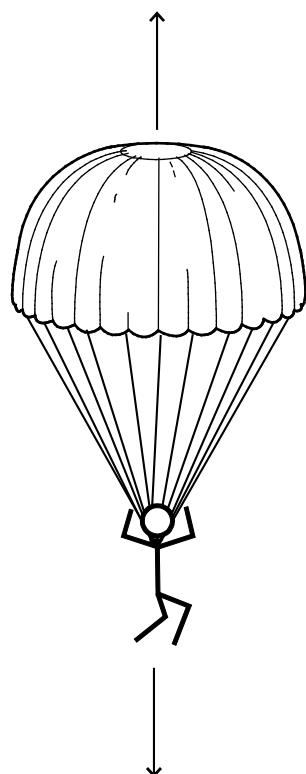

Which line in the table gives the size and direction of the acceleration of the parachutist at this instant?

	<i>size of acceleration / ms<sup>-2</sup></i>	<i>direction of acceleration</i>
<b>A</b>	5.0	downwards
<b>B</b>	10.0	downwards
<b>C</b>	5.0	upwards
<b>D</b>	10.0	upwards
<b>E</b>	0.0	—

- 20 The displacement–time graph shown represents a wave of wavelength 1.5 cm.

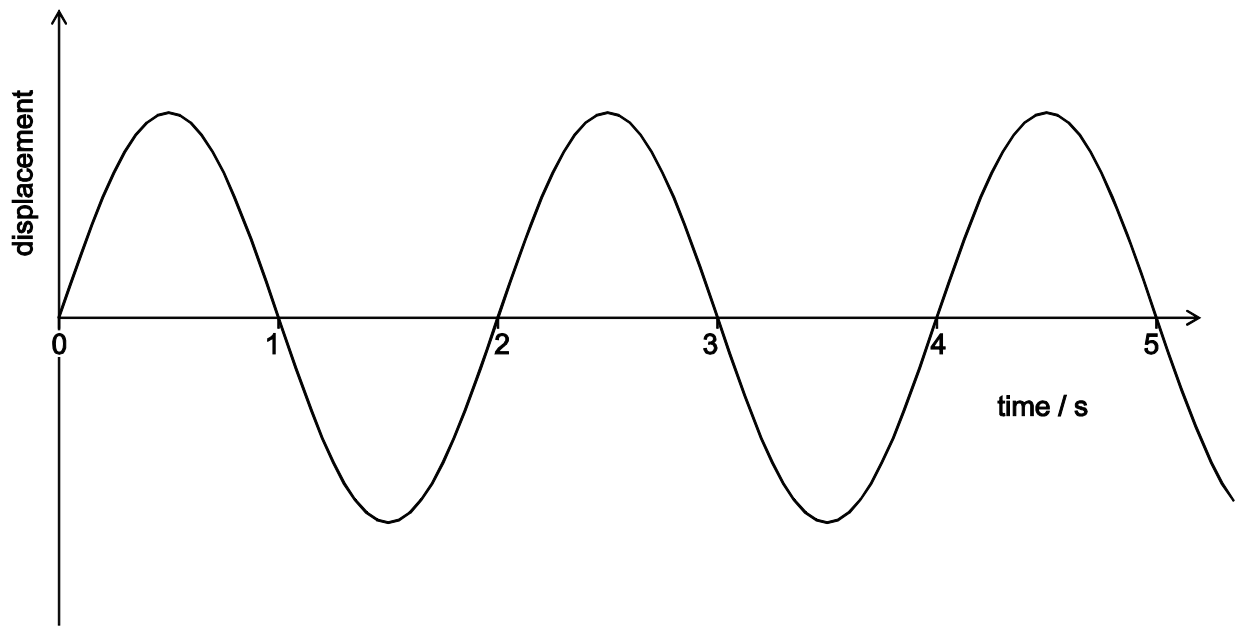

What is the speed of the wave?

- A  $0.33 \text{ cm s}^{-1}$
  - B  $0.67 \text{ cm s}^{-1}$
  - C  $0.75 \text{ cm s}^{-1}$
  - D  $1.33 \text{ cm s}^{-1}$
  - E  $1.5 \text{ cm s}^{-1}$
  - F  $3.0 \text{ cm s}^{-1}$
- 21 A point mass travelling at a constant speed has a momentum of 30 N s and a kinetic energy of 150 J.

What is the mass of the object?

- A 2 kg
- B 3 kg
- C 5 kg
- D 6 kg
- E 10 kg
- F 15 kg

PART B Physics

22 Which of the following is a correct unit of potential difference (voltage)?

- A amp per ohm
- B coulomb per joule
- C joule per second
- D newton per coulomb
- E watt per amp

23 A radioactive isotope decays to a stable product. A sample of this isotope is placed near to a radiation detector in a laboratory.

A graph of count rate against time was plotted to display the data from the detector.

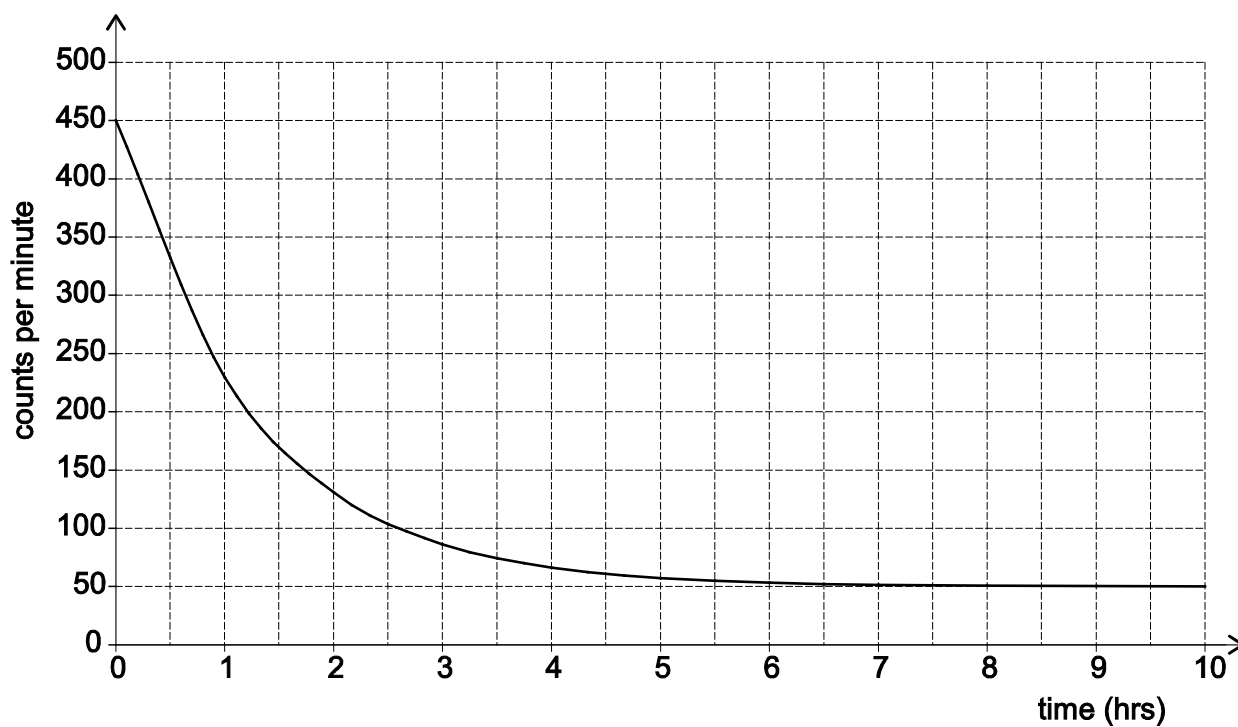

What is the approximate count rate due to background radiation for this experiment?

- A 5 counts per minute
- B 25 counts per minute
- C 45 counts per minute
- D 50 counts per minute
- E 200 counts per minute
- F 225 counts per minute

- 24 An object of mass 5.0 kg falls from rest and hits the ground at a speed of  $20 \text{ m s}^{-1}$ . Air resistance is negligible.

From what height has the object fallen?

(gravitational field strength =  $10 \text{ N kg}^{-1}$ )

- A 10 m  
 B 20 m  
 C 50 m  
 D 100 m  
 E 200 m  
 F 1000 m
- 25 A cyclist and a bike have a combined mass of 100 kg. The cyclist free-wheels (rolls without pedalling) at a constant speed of  $0.80 \text{ m s}^{-1}$  down a slope where the cyclist descends 1.0 m for each 10 m travelled along the road, as shown in the diagram.

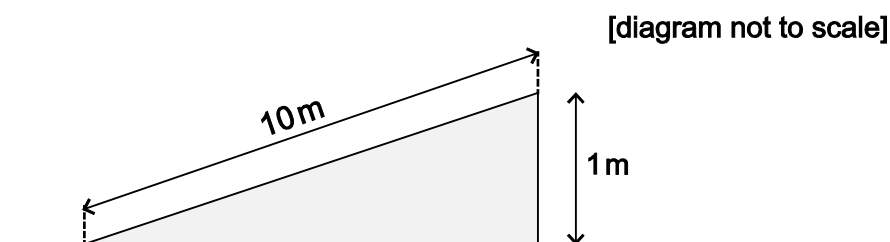

Calculate the loss in gravitational potential energy as the cyclist loses 100 m in vertical height and hence calculate the total resistive force on the cyclist and bike.

(gravitational field strength =  $10 \text{ N kg}^{-1}$ )

	<i>loss in gravitational potential energy / J</i>	<i>resistive force / N</i>
<b>A</b>	3200	$32/\sqrt{101}$
<b>B</b>	3200	3.2
<b>C</b>	3200	$32/\sqrt{99}$
<b>D</b>	100 000	$1000/\sqrt{101}$
<b>E</b>	100 000	100
<b>F</b>	100 000	$1000/\sqrt{99}$

PART B Physics

- 26** An electric motor is used to lift a load of 3.0 kg from rest through a height of 5.0 m in a time of 1.5 s. At the end of the lift the load is at rest again. The motor is connected to a 25 V dc supply.

Assuming that the system is 100% efficient, what is the average current in the motor during the lift?

(gravitational field strength =  $10 \text{ N kg}^{-1}$ )

- A** 0.40 A
  - B** 0.60 A
  - C** 0.80 A
  - D** 4.0 A
  - E** 9.0 A
- 27** A ball is thrown vertically upwards and leaves the thrower's hand with a speed of  $12 \text{ m s}^{-1}$ . You may assume that all of the initial kinetic energy of the ball has been converted into gravitational potential energy when the ball reaches its highest point.

What is the height above the thrower's hand to which it rises?

(gravitational field strength =  $10 \text{ N kg}^{-1}$ )

- A** 7.2 m
- B** 14.4 m
- C** 24 m
- D** 60 m
- E** 120 m

- 28 A lorry of mass  $m$ , and travelling initially at speed  $v$  along a horizontal road, is brought to rest by an average horizontal braking force  $F$  in time  $t$ .

Ignoring any other resistive forces, what distance is travelled by the lorry during this time?

(gravitational field strength =  $g$ )

- A  $\frac{F}{mg}$
- B  $\frac{mgv}{F}$
- C  $\frac{mv^2}{2F}$
- D  $\frac{v^2}{2g}$
- E  $vt$
- F  $2vt$

- 29 Nuclide  ${}^N_R X$  is an unstable isotope which decays in two stages into nuclide  $Z$  as shown:

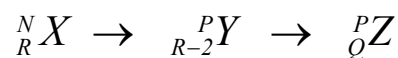

What are the values of  $P$  and  $Q$ ?

(Consider only alpha and beta decays.)

	$P$	$Q$
A	$N - 4$	$R + 1$
B	$N - 4$	$R - 1$
C	$N - 4$	$R - 2$
D	$N$	$R - 1$
E	$N$	$R - 2$
F	$N$	$R - 4$

PART B Physics

- 30** A pulse of frequency 100 kHz is emitted from an ultrasound scanner, and is reflected from a foetus 10 cm below the transmitter placed on the mother's abdomen. The speed of sound within the mother's body is  $500 \text{ m s}^{-1}$ .

How long after its emission from the scanner does it take for the pulse to reach the receiver which is adjacent to the transmitter?

- A** 0.20 ms
- B** 0.40 ms
- C** 0.50 ms
- D** 0.80 ms
- E** 1.0 ms



- 31 The diagrams below show either velocity–time or distance–time graphs for four different objects, P, Q, R and S.

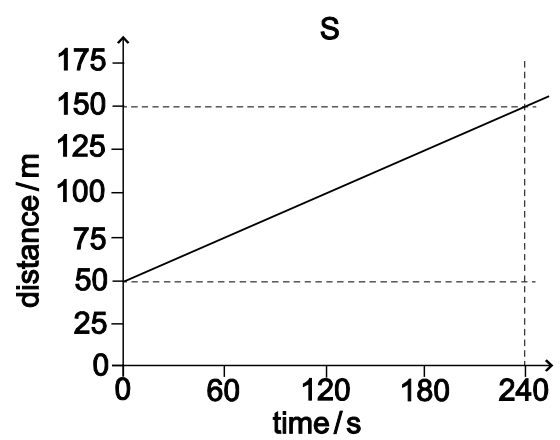
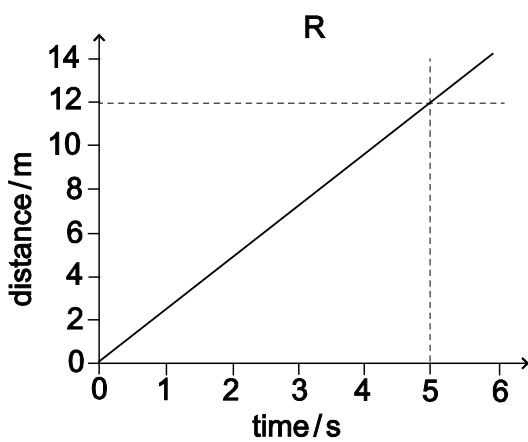
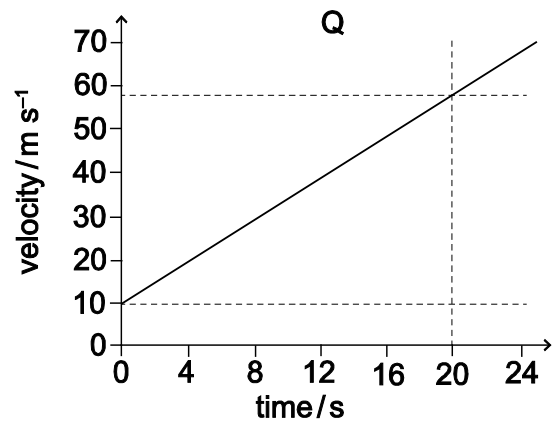
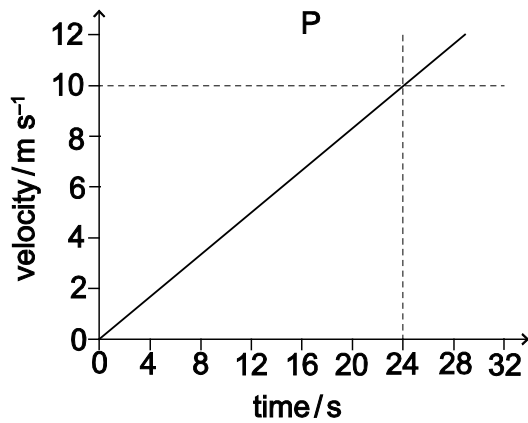

Which graph(s) show an object accelerating at  $2.4 \text{ m s}^{-2}$ ?

- A P only
- B Q only
- C R only
- D S only
- E P and Q only
- F Q and R only
- G P and S only

PART B Physics

32 Consider this graph.

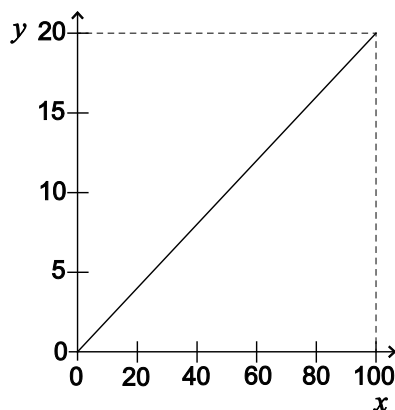

Which one of the following could the graph **not** represent if all quantities are in SI units?

- A The variation of the acceleration ( $y$ -axis) of a body of mass  $5.0\text{ kg}$  with the resultant force acting on the body ( $x$ -axis).
- B The variation of the current ( $y$ -axis) through a  $5.0\ \Omega$  resistor with the applied voltage ( $x$ -axis).
- C The variation of the kinetic energy ( $y$ -axis) of a body of mass  $0.4\text{ kg}$  with the square of its speed ( $x$ -axis).
- D The variation of the wavelength ( $y$ -axis) of waves with a speed of  $0.2\text{ m s}^{-1}$  with their frequency ( $x$ -axis).
- E The variation of the work done ( $y$ -axis) by a force of  $0.2\text{ N}$  with the distance it moves through in the direction of the force ( $x$ -axis).

33 The nucleus of the ion  $\text{Q}^{2+}$  contains  $x$  neutrons and  $x - 3$  protons.

How many electrons does the  $\text{Q}^{2+}$  ion contain?

- A  $x - 1$
- B  $x - 2$
- C  $x - 5$
- D  $2x - 1$
- E  $2x - 5$

- 34** Two resistors with resistance  $R_1$  ohms and  $R_2$  ohms are connected in series with a battery that has a voltage  $V$  across its terminals.

Which formula gives the power dissipated by the resistor with resistance  $R_1$  ohms?

**A**  $\frac{VR_1}{R_1 + R_2}$

**B**  $\frac{V^2R_1}{R_1 + R_2}$

**C**  $\frac{VR_1}{(R_1 + R_2)^2}$

**D**  $\frac{V^2R_1}{(R_1 + R_2)^2}$

**E**  $\frac{VR_1^2}{(R_1 + R_2)}$

**F**  $\frac{V^2R_1^2}{(R_1 + R_2)^2}$

35 The graph represents the motion of a vehicle during part of a journey.

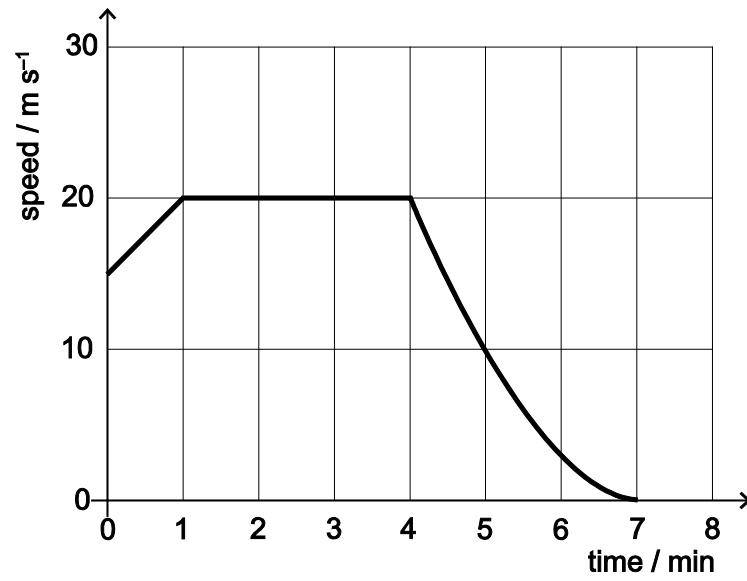

What is the best estimate of the distance travelled during the part of the journey shown?

- A 100.00 m
- B 107.50 m
- C 115.00 m
- D 6.00 km
- E 6.45 km
- F 6.90 km

- 36 A sound wave is produced by a loudspeaker cone, which creates pulses of pressure by moving back and forth between two points  $X$  and  $Y$  as shown in the diagram.

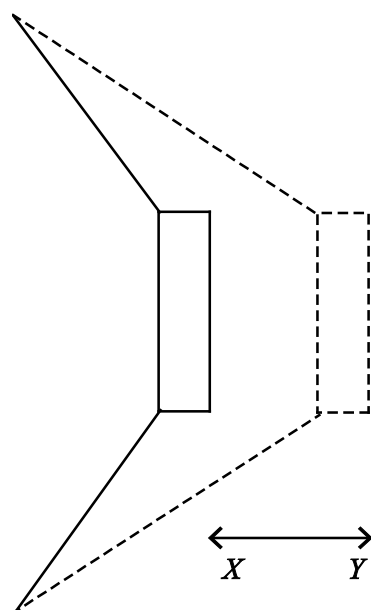

The distance between points  $X$  and  $Y$  is 5.0 mm and the loudspeaker produces pulses of high pressure every 0.20 milliseconds.

The following statements about the sound wave produced are made:

- P** It has a speed of  $25 \text{ m s}^{-1}$ .
- Q** It has an amplitude of 5.0 mm.
- R** It has a wavelength of 5.5 mm.
- S** It has a frequency of 5.0 kHz.

Which of these statements can be correctly deduced from the information given?

- A** P only
- B** S only
- C** P and Q only
- D** P and R only
- E** Q and S only
- F** R and S only
- G** P, R and S only

**BLANK PAGE**

**PART C Chemistry**

- 37 The colours of three indicators are shown.

<i>indicator</i>	<i>colour at</i>		<i>pH at which colour change takes place</i>
	<i>low pH</i>	<i>high pH</i>	
methyl orange	red	yellow	4.0
bromothymol blue	yellow	blue	6.5
phenolphthalein	colourless	pink	9.0

Equal volumes of these three indicators were mixed and the mixture was added to a solution of pH 5.0.

What colour would be seen?

- A blue
  - B green
  - C orange
  - D purple
  - E yellow
- 38 When concentrated aqueous sodium chloride solution is electrolysed using inert electrodes a reaction occurs at each electrode.
- Which is the correct combination of elements actually produced at the electrodes in this electrolysis?
- A positive electrode = chlorine; negative electrode = hydrogen
  - B positive electrode = chlorine; negative electrode = sodium
  - C positive electrode = oxygen; negative electrode = hydrogen
  - D positive electrode = oxygen; negative electrode = sodium
  - E positive electrode = sodium; negative electrode = chlorine



39 Which substance (**A-E**) in the table could have a giant covalent structure?

<i>substance</i>	<i>melting point / °C</i>	<i>boiling point / °C</i>	<i>electrical conductivity</i>	
			<i>when solid</i>	<i>when molten</i>
<b>A</b>	1700	2200	none	none
<b>B</b>	800	1470	none	good
<b>C</b>	98	880	good	good
<b>D</b>	-20	58	none	none
<b>E</b>	-39	357	good	good

- 40 Chemicals A and B react to form products Y and Z. The reaction goes to completion. The equation for the reaction is:

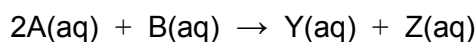

Equimolar samples of A and B were mixed and the concentrations of A and Z were measured over time. Which of the following graphs could represent this reaction?

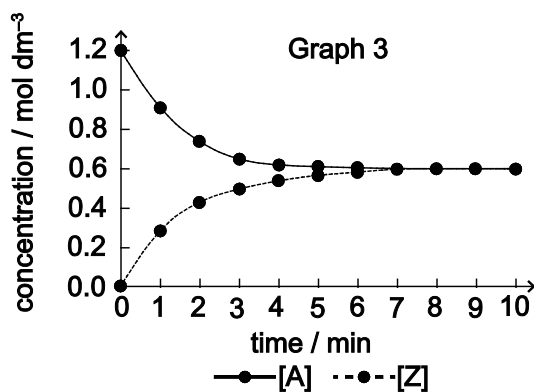
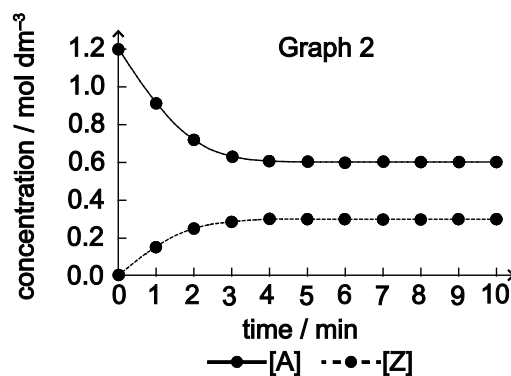
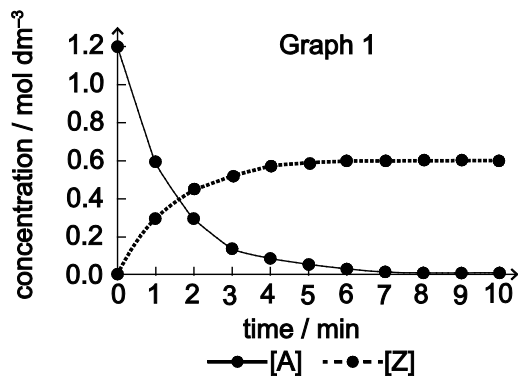

- A Graph 1 only  
 B Graph 2 only  
 C Graph 3 only  
 D Graphs 1 and 2 only  
 E Graphs 2 and 3 only

- 41 An oxide of iron has the formula  $\text{Fe}_3\text{O}_4$  and contains both  $\text{Fe}^{2+}$  and  $\text{Fe}^{3+}$  ions.

Which one of the following is the fraction of iron ions that are in the  $\text{Fe}^{2+}$  state?

- A  $\frac{1}{4}$
- B  $\frac{1}{3}$
- C  $\frac{1}{2}$
- D  $\frac{2}{3}$
- E  $\frac{3}{4}$

- 42 An element has a mass number of 40 and an atomic number of 20.

Which statement(s) about this element is/are correct?

- 1 Its atomic nucleus has a relative mass of 20.
  - 2 It is a noble gas.
  - 3 It would form a negative ion.
  - 4 It is in Group 2 of the Periodic Table.
  - 5 It is a non-metallic element.
- 
- A 1, 2 and 3 only
  - B 1, 3 and 4 only
  - C 1, 4 and 5 only
  - D 2, 3 and 5 only
  - E 4 only
  - F 5 only

- 43 The reaction between nitrogen and hydrogen to form ammonia is exothermic.

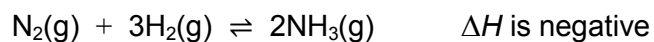

The bond energies in the three molecules are as shown:

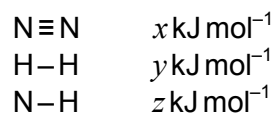

Which statement can be deduced from this information?

- A  $z > x + y$   
 B  $2z > x + y$   
 C  $2z > x + 3y$   
 D  $6z > x + 3y$
- 44 In which two of the following equations is the **first reactant** an oxidising agent?

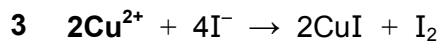
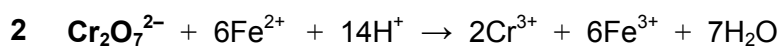
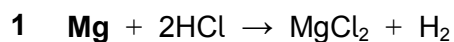

- A 1 and 2  
 B 1 and 4  
 C 2 and 3  
 D 2 and 4  
 E 3 and 4

- 45** What volume of water vapour measured at room temperature and pressure would be produced from an ice cube of mass 6.00 g if it all evaporated?

( $A_r$  values: H = 1; O = 16. Molar volume of a gas at room temperature and pressure = 24 dm<sup>3</sup>)

- A** 240 cm<sup>3</sup>
- B** 1800 cm<sup>3</sup>
- C** 4800 cm<sup>3</sup>
- D** 8000 cm<sup>3</sup>
- E** 24 000 cm<sup>3</sup>

- 46** A compound of iodine and oxygen contains 63.5 g of iodine and 20.0 g of oxygen.

Which one of the following is its empirical formula?

( $A_r$  values: I = 127; O = 16)

- A** IO
- B** IO<sub>2</sub>
- C** I<sub>2</sub>O
- D** I<sub>2</sub>O<sub>3</sub>
- E** I<sub>2</sub>O<sub>5</sub>
- F** I<sub>5</sub>O<sub>2</sub>

- 47** Listed are the electron configurations for the atoms of different elements.

Which one represents the most reactive non-metal?

- A** 2,4
- B** 2,6
- C** 2,7
- D** 2,8,1
- E** 2,8,6
- F** 2,8,7

## PART C Chemistry

- 48** Naturally occurring chlorine is a mixture of two isotopes with mass number 35 and 37. The isotope with mass number 35 is three times as common as the isotope with mass number 37.

Naturally occurring bromine is a mixture of two isotopes with mass numbers 79 and 81. They are present in equal amounts.

What fraction of the naturally occurring compound  $\text{CH}_2\text{BrCl}$  has a relative molecular mass of 128?

( $A_r$  values: H = 1; C = 12)

- A**  $\frac{1}{8}$   
**B**  $\frac{1}{4}$   
**C**  $\frac{3}{8}$   
**D**  $\frac{1}{2}$   
**E**  $\frac{5}{8}$

- 49** A mixture of equal parts of hexane (bp  $68^\circ\text{C}$ ) and heptane (bp  $98^\circ\text{C}$ ) is distilled using a fractionating column.

The temperature of the liquid in the flask and the temperature at the top of the fractionating column are measured.

Which one of the following shows the likely temperatures when the first drops of distillate are collected?

	<i>temperature in flask / °C</i>	<i>temperature at top of column / °C</i>
<b>A</b>	83	68
<b>B</b>	98	68
<b>C</b>	83	83
<b>D</b>	98	83
<b>E</b>	98	98

- 50** Carbon, in the form of coke, is used to reduce iron oxide in a blast furnace. The three stages are shown below:

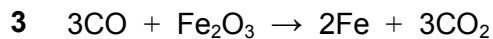
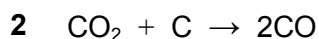
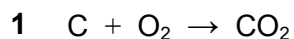

If 12 g of carbon is used in stage 2 and all the carbon monoxide produced is used in stage 3, what mass of carbon dioxide is produced in stage 3?

( $A_r$  values: C = 12; O = 16)

- A** 17.8 g
- B** 35.6 g
- C** 44 g
- D** 88 g
- E** 132 g
- 51** The following exothermic, reversible reaction is used in the manufacture of sulfuric acid from sulfur dioxide and oxygen:

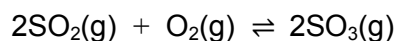

Which one of the following statements about this reaction is correct?

- A** Pressure has no effect on the position of equilibrium.
- B** Raising the temperature moves the equilibrium to the right.
- C** At equilibrium no sulfur dioxide is being changed into sulfur trioxide.
- D** The addition of a catalyst speeds up the forward reaction more than the backward reaction.
- E** Before equilibrium is reached, the rate of the forward reaction is greater than the rate of the backward reaction.

PART C Chemistry

- 52** An impure sample of sodium hydroxide has a mass of 1.20 g. All the sodium hydroxide completely reacts with a minimum of 50.0 cm<sup>3</sup> of 0.50 mol dm<sup>-3</sup> hydrochloric acid.

What is the percentage purity of the sodium hydroxide sample?

(A<sub>r</sub> values: H = 1; O = 16; Na = 23; Cl = 35.5)

- A** 37.5%
  - B** 41.6%
  - C** 72.7%
  - D** 75.0%
  - E** 83.3%
  - F** 90.4%
- 53** A sample of an alkali XOH of mass 2.8 g was dissolved in water.

This solution was neutralised by 12.5 cm<sup>3</sup> of sulfuric acid of concentration 2.0 mol dm<sup>-3</sup>.

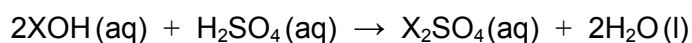

What is the relative atomic mass of X?

(A<sub>r</sub> values: H = 1; O = 16; S = 32)

- A** 13
- B** 26
- C** 39
- D** 52
- E** 65
- F** 78



- 54 The equation summarises the reaction of copper and dilute nitric acid.

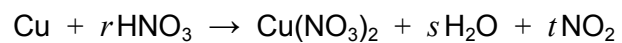

What values of  $s$  and  $t$  are needed to balance the equation?

	$s$	$t$
A	1	1
B	2	1
C	4	1
D	2	2
E	4	2

**BLANK PAGE**

**PART D Biology**

PART D Biology

**55** Which of the following describe(s) a role of mitosis?

- 1** formation of gametes
  - 2** growth of cells
  - 3** repair of cells
  - 4** replacement of skin cells
- 
- A** 1 only
  - B** 2 only
  - C** 3 only
  - D** 4 only
  - E** 1 and 2 only
  - F** 3 and 4 only
  - G** 1, 3 and 4 only
  - H** 1, 2, 3 and 4

56 The graph shows oxygen supply and demand in muscle cells during exercise.

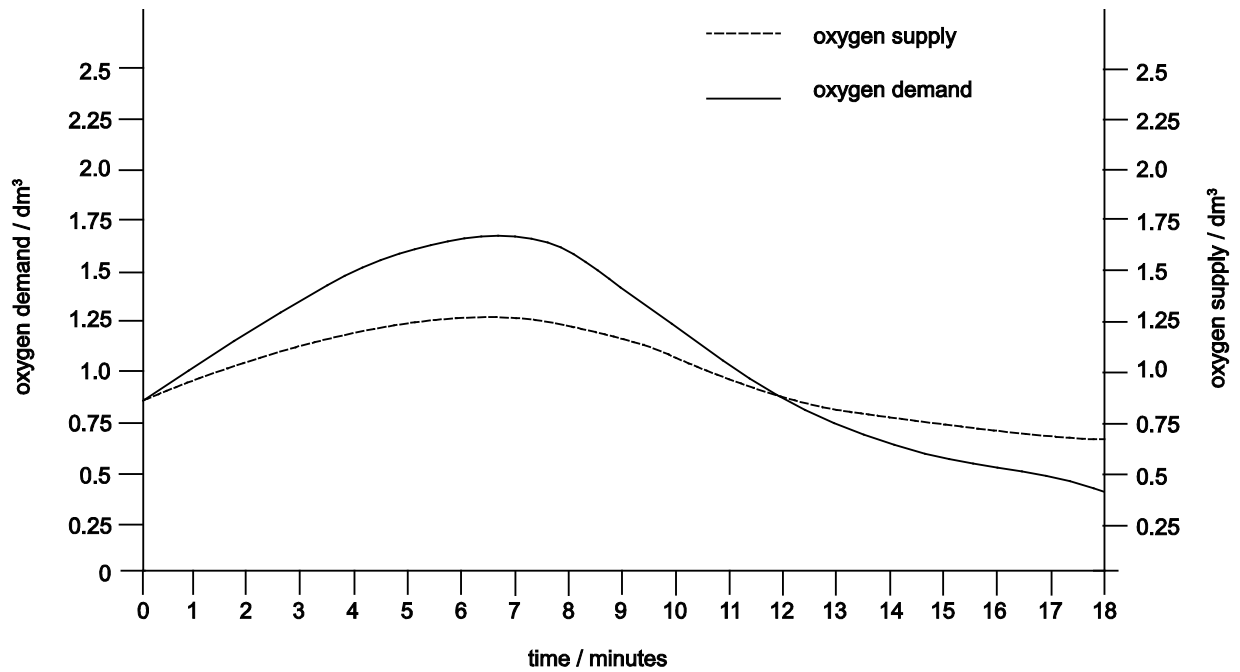

Which statement correctly describes what is happening in the muscle cells between 0 and 11 minutes?

- A Anaerobic respiration only is taking place.
- B More oxygen is being supplied than is required.
- C Aerobic respiration only is taking place.
- D Both anaerobic and aerobic respiration are taking place.

PART D Biology

**57** Which of the four statements below about natural selection are correct?

- 1** Competition occurs between individuals of the same species.
  - 2** Competition occurs between individuals of different species.
  - 3** Selection can lead to evolution.
  - 4** Selection can lead to extinction.
- 
- A** 1 and 3 only
  - B** 2 and 4 only
  - C** 1, 2 and 4 only
  - D** 1, 3 and 4 only
  - E** 2, 3 and 4 only
  - F** 1, 2, 3 and 4

- 58** A student carried out an experiment to investigate the effect of temperature on the rate of photosynthesis. All of the other variables were kept constant.

The graph shows the results obtained.

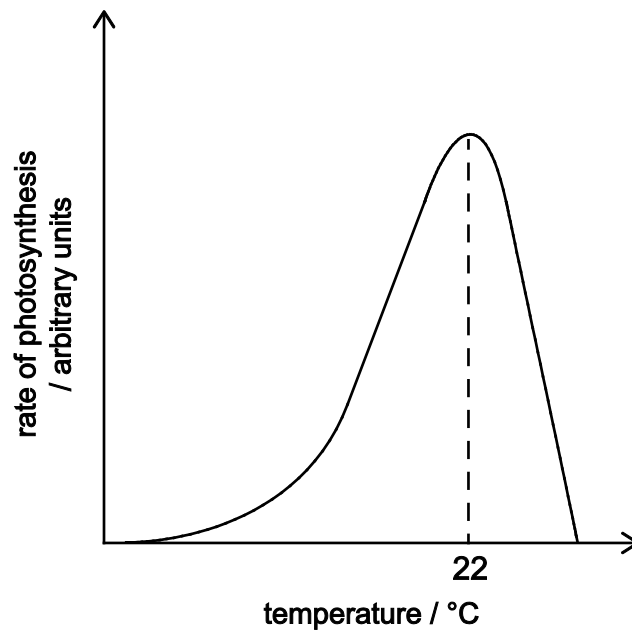

The student considered the graph and made the following conclusions.

- 1 Up to 22 °C temperature is limiting the rate of photosynthesis.
- 2 At temperatures higher than 22 °C not all of the enzymes work so the rate of photosynthesis drops.
- 3 As the temperature increases across the temperature range studied, the rate of photosynthesis increases due to increased kinetic energy.

Which of the student's conclusions is/are correct?

- A none of them
- B 1 only
- C 2 only
- D 3 only
- E 1 and 2 only
- F 1 and 3 only
- G 2 and 3 only
- H 1, 2 and 3

PART D Biology

59 The karyogram below is a photograph of the chromosomes taken from a single human cell.

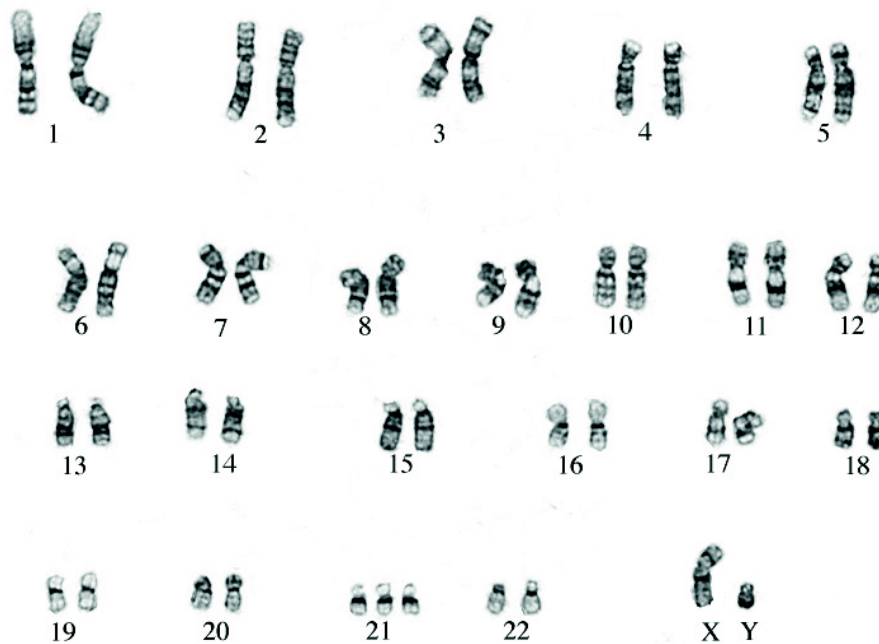

Using the karyogram, which of the following statements is/are correct?

- 1 The person is healthy with no visible mutations.
  - 2 These chromosomes come from a male cell.
  - 3 The cell used could have been a white blood cell.
- 
- A none of them
  - B 1 only
  - C 2 only
  - D 3 only
  - E 1 and 2 only
  - F 1 and 3 only
  - G 2 and 3 only
  - H 1, 2 and 3

Image used with permission of UW Cytogenetics/Wisconsin State Laboratory of Hygiene © Board of Regents of the University of Wisconsin System



- 60** Which of the following statements is/are correct about a stem cell extracted from the bone marrow of a healthy human donor to be given to a patient?
- 1** It can undergo meiosis to form genetically identical offspring.
  - 2** It may contain 46 chromosomes.
  - 3** It could differentiate to become a white blood cell.
- A** none of them
- B** 1 only
- C** 2 only
- D** 3 only
- E** 1 and 2 only
- F** 1 and 3 only
- G** 2 and 3 only
- H** 1, 2 and 3
- 
- 61** Tomato plants were placed in sunlight in an atmosphere containing radioactively labelled carbon dioxide. After a period of time, radioactively labelled sugars were detected in the roots of the plants.
- Which of the following statements is correct?
- A** Carbon dioxide diffused into the roots where it was converted into sugars.
- B** Carbon dioxide entering the leaves was used to make sugars, some of which was transported by translocation to the roots.
- C** Carbon dioxide entering the leaves was used to make sugars, some of which was transported by transpiration to the roots.
- D** Carbon dioxide entering the leaves was transported by translocation to the roots where it was converted into sugars.
- E** Carbon dioxide entering the leaves was transported by transpiration to the roots where it was converted into sugars.

PART D Biology

- 62 A person's ear lobes can be attached to the side of their head or unattached. The allele for attached ear lobes is recessive to the allele for unattached ear lobes.

The pedigree diagram below shows the ear lobe attachment in one family.

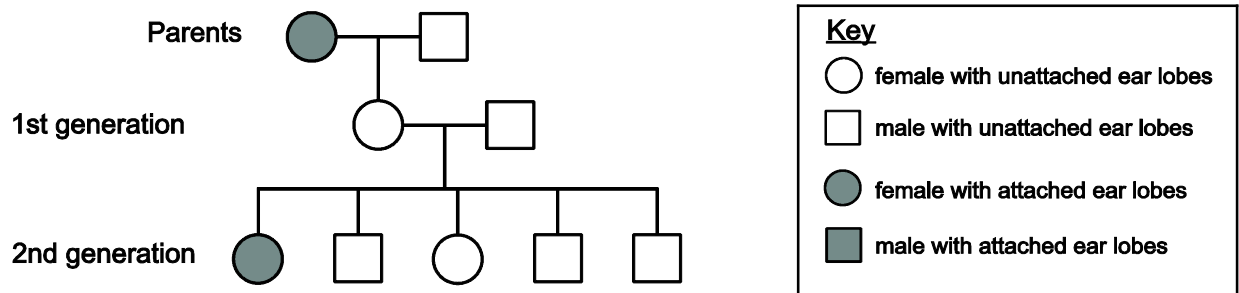

What is the maximum possible number of heterozygous individuals in this pedigree diagram?

- A 2
- B 3
- C 4
- D 5
- E 6
- F 7
- G 8
- H 9

- 63 The graph below shows the effect of different concentrations of sodium chloride (NaCl) solution on the percentage haemolysis of human red blood cells. Haemolysis occurs when the cells swell and then burst open.

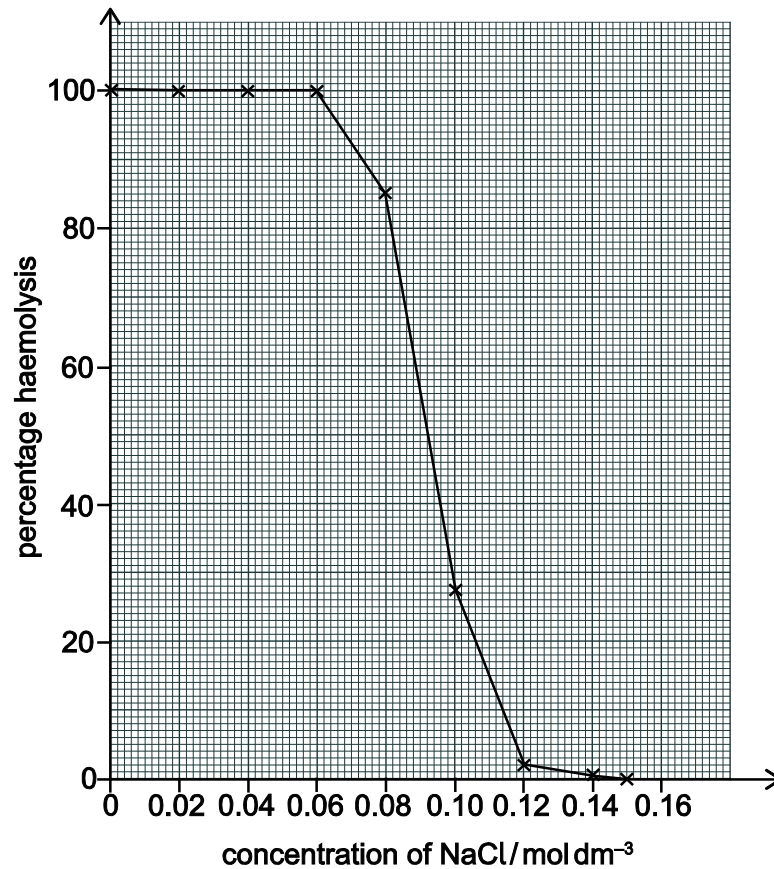

Which letter correctly describes the effect of changing the concentration of NaCl from 0.12 mol dm<sup>-3</sup> to 0.084 mol dm<sup>-3</sup> on percentage haemolysis?

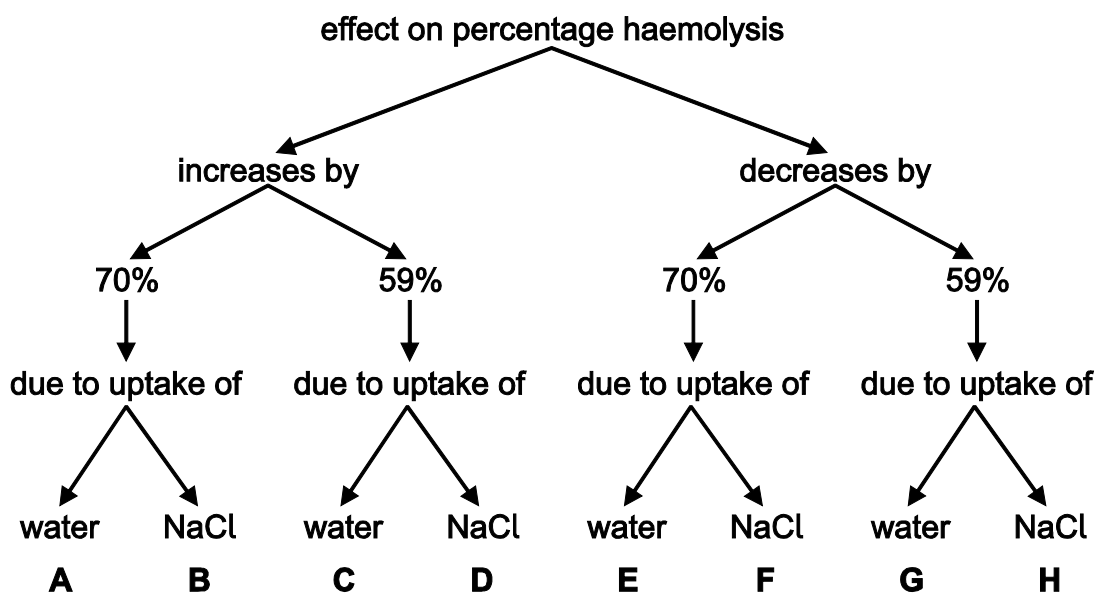

64 The graph shows how body temperature of a human varies over a period of 60 minutes.

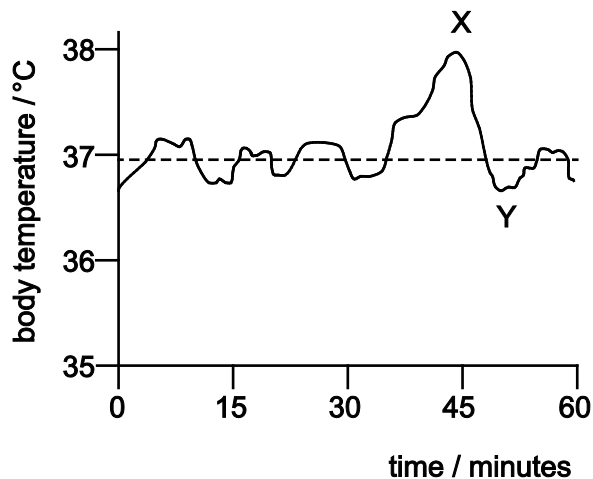

Which of the following could have caused the temperature change between X and Y?

- 1 Homeostasis causing more sweat production.
- 2 The temperature control centre in the brain causing hairs on the skin to stand up on end.
- 3 The temperature control centre in the brain causing less blood to flow near the skin's surface.

- A** none of them
- B** 1 only
- C** 2 only
- D** 3 only
- E** 1 and 2 only
- F** 1 and 3 only
- G** 2 and 3 only
- H** 1, 2 and 3

- 65 An isolated island in Canada has populations of moose and wolves. Moose are the main source of food for the wolves. The graph shows changes in the populations of the two species of animal from 1959 to 2008.

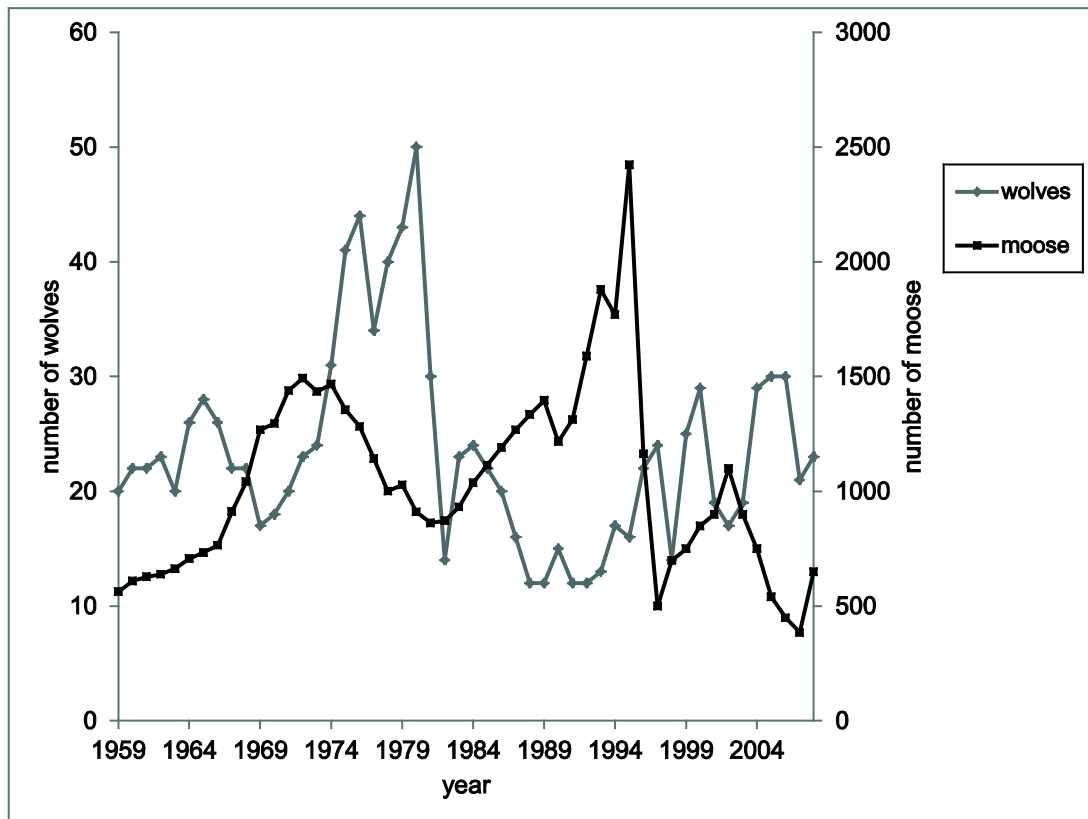

A student listed four trends in the populations of moose and wolves from 1959 to 2008.

- 1 Increases in wolf population are always after increases in moose population.
- 2 The wolf population is always lower than the moose population.
- 3 There were more wolves than moose in 1965.
- 4 When the wolf population is low there is an increase in the moose population.

Which of the student's statements are correct?

- A 1 and 2 only
- B 1 and 3 only
- C 1 and 4 only
- D 2 and 4 only
- E 3 and 4 only

PART D Biology

- 66** The sex of a species of fruit fly is determined by the number of X chromosomes relative to the number of non-sex chromosomes (A) in a cell. This is called the X:A ratio.

A fruit fly will be male if X:A = 0.5:1, and female if X:A = 1:1

The Y chromosome contains genes necessary for making sperm.

Which row of the table correctly shows the sex of the five fruit flies with different numbers of these chromosomes?

	XAA	XYAA	XXAA	XXYAA	XXYYAA
<b>A</b>	female	female	female	male	male
<b>B</b>	female	female	male	male	male
<b>C</b>	female	male	female	male	female
<b>D</b>	female	male	female	male	male
<b>E</b>	male	female	male	female	female
<b>F</b>	male	female	male	female	male
<b>G</b>	male	male	female	female	female
<b>H</b>	male	male	female	female	male

67 The diagram shows part of the carbon cycle.

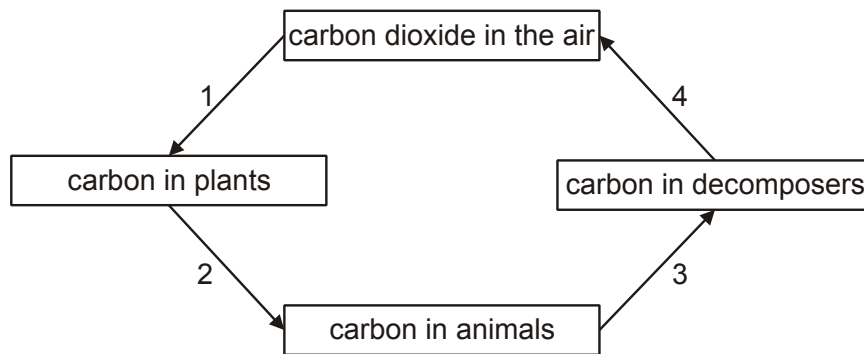

Which row shows the numbered processes that use digestive or respiratory enzymes?

	<i>process or processes that involve digestive enzymes</i>	<i>process or processes that involve respiratory enzymes</i>
<b>A</b>	1 only	2 and 3 only
<b>B</b>	2 only	1 and 4 only
<b>C</b>	3 only	2 and 4 only
<b>D</b>	4 only	2 and 3 only
<b>E</b>	2 and 3 only	1 only
<b>F</b>	3 and 4 only	2 only
<b>G</b>	1 and 4 only	3 only
<b>H</b>	2 and 3 only	4 only

PART D Biology

**68** A section of DNA is 420 base pairs long and contains 42% of one of the bases, adenine (A).

Which one of the following rows in the table correctly states how many amino acids can be coded for by this section of DNA and what percentage of the base guanine (G) is present in this section of DNA?

	<i>number of amino acids</i>	<i>percentage of guanine (G)</i>
<b>A</b>	140	8
<b>B</b>	140	13
<b>C</b>	140	42
<b>D</b>	260	16
<b>E</b>	260	42
<b>F</b>	420	8
<b>G</b>	420	13
<b>H</b>	420	16

**69** Which of the statements about the genetic modification of a bacterium to produce human insulin are correct?

- 1 Human insulin DNA is cut out using an enzyme.
- 2 This DNA is inserted into the nucleus of a bacterium.
- 3 The modified bacterium is cultured.
- 4 The bacterial cells are injected into humans with diabetes.

- A** 1 and 2 only
- B** 1 and 3 only
- C** 2 and 4 only
- D** 3 and 4 only
- E** 1, 2 and 3 only
- F** 1, 3 and 4 only



- 70** Which of the following could be produced when a mutation occurs in a cheek cell of an organism?
- 1** a change in the sequence of amino acids used to make a protein
  - 2** an advantageous allele that can be passed on to the offspring of that organism
  - 3** a change of an essential cell process that causes the death of the cell
- A** none of them
- B** 1 only
- C** 2 only
- D** 3 only
- E** 1 and 2 only
- F** 1 and 3 only
- G** 2 and 3 only
- H** 1, 2 and 3

PART D Biology

- 71 The genetic condition represented by the shading is caused by the presence of at least one allele for the condition.

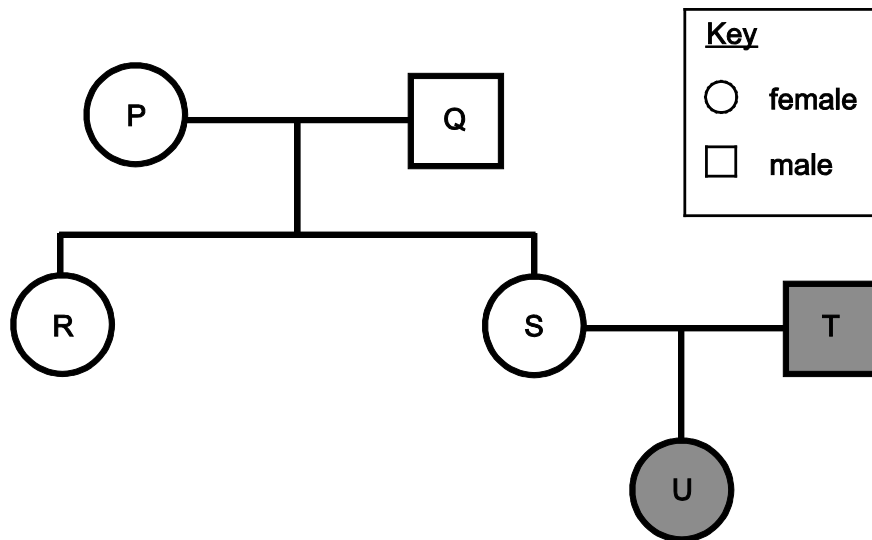

Which of the following are possible reasons why U has the condition?

- 1 The condition is dominant.
  - 2 The sperm from T carried the allele for the condition.
  - 3 A mutation is present in an egg of S.
- A** none of them  
**B** 1 and 2 only  
**C** 1 and 3 only  
**D** 2 and 3 only  
**E** 1, 2 and 3

**72** Which of the following could be found in an adult liver cell?

- 1** starch
  - 2** at least one X chromosome
  - 3** gene for amylase
- 
- A** none of them
  - B** 1 only
  - C** 2 only
  - D** 3 only
  - E** 1 and 2 only
  - F** 1 and 3 only
  - G** 2 and 3 only
  - H** 1, 2 and 3

**BLANK PAGE**

**PART E Advanced Mathematics and Advanced Physics**

73 Given that  $a^x b^{2x} c^{3x} = 2$ , where  $a$ ,  $b$  and  $c$  are positive real numbers, then  $x =$

A  $\log_{10} \left( \frac{2}{a + 2b + 3c} \right)$

B  $\frac{\log_{10} 2}{\log_{10} (a + 2b + 3c)}$

C  $\frac{2}{\log_{10} (a + 2b + 3c)}$

D  $\frac{2}{a + 2b + 3c}$

E  $\log_{10} \left( \frac{2}{ab^2c^3} \right)$

F  $\frac{\log_{10} 2}{\log_{10} (ab^2c^3)}$

G  $\frac{2}{\log_{10} (ab^2c^3)}$

H  $\frac{2}{ab^2c^3}$

74 Particle P has a fixed mass of 2 kg and particle Q has a fixed mass of 5 kg.

The two particles are moving in opposite directions along a straight line on a smooth plane.

Particle P has a speed of  $3 \text{ m s}^{-1}$  and particle Q has a speed of  $r \text{ m s}^{-1}$ .

The particles collide directly. After the collision the direction of each particle is reversed.

The speed of P is now  $1 \text{ m s}^{-1}$  and the speed of Q is halved.

What is the value of  $r$ ?

A  $\frac{8}{15}$

B  $\frac{14}{15}$

C  $\frac{16}{15}$

D  $\frac{8}{3}$

E  $\frac{16}{5}$

75 Which one of the following numbers is largest in value?

(All angles are given in radians.)

A  $\tan\left(\frac{3\pi}{4}\right)$

B  $\log_{10} 100$

C  $\sin^{10}\left(\frac{\pi}{2}\right)$

D  $\log_2 10$

E  $(\sqrt{2} - 1)^{10}$

- 76 A parachutist falls from an aircraft and reaches a terminal velocity. After a while he opens his parachute and reaches a new (lower) terminal velocity.

Which graph shows how the total air resistance (drag) force acting on him and the parachute varies with time during the fall?

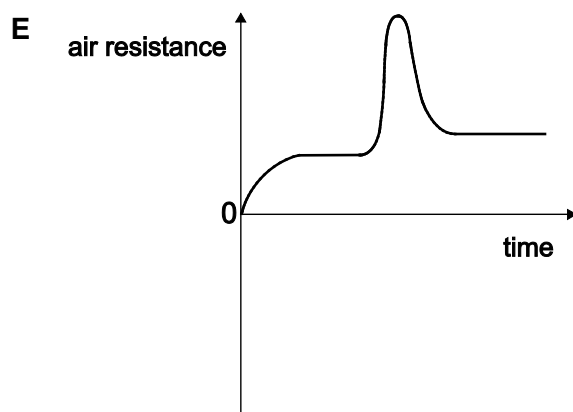
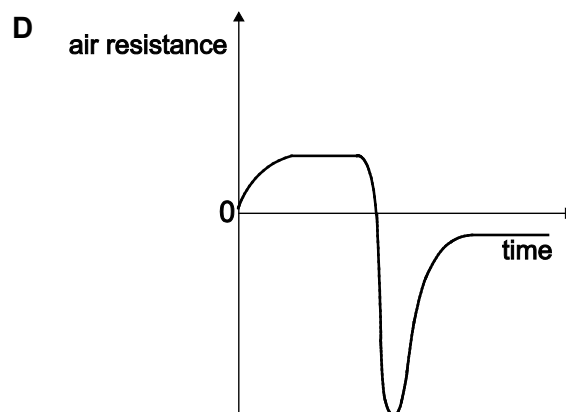
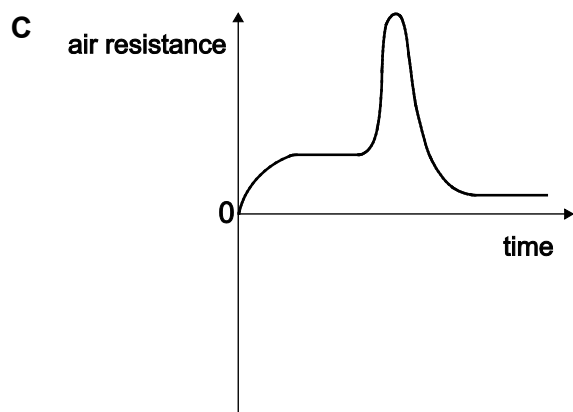
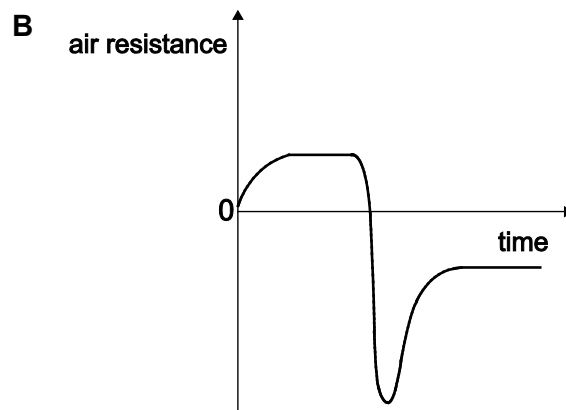
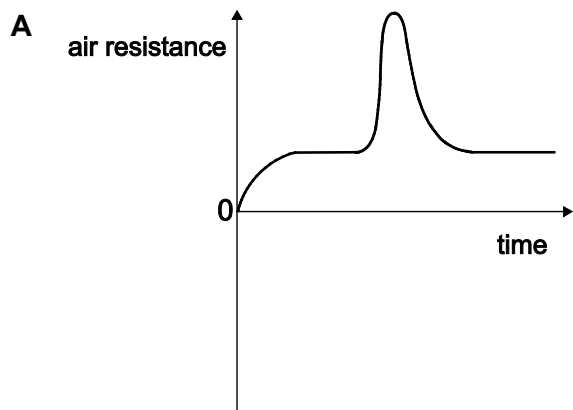



77 The sum of the roots of the equation  $2^{2x} - 8 \times 2^x + 15 = 0$  is

- A 3
- B 8
- C  $2\log_{10} 2$
- D  $\log_{10} \left( \frac{15}{4} \right)$
- E  $\frac{\log_{10} 15}{\log_{10} 2}$

78 A heavy block of stone rests on a rough, horizontal surface.

The block is subject to a horizontal force that increases from zero at a constant rate.

Assume that the coefficient of friction is greater than zero and that its value is independent of whether or not the block is moving.

What happens to the block of stone?

(Assume air resistance is negligible.)

- A It moves forwards immediately and accelerates forwards with a constant acceleration.
- B It remains stationary at first and then accelerates forwards with a constant acceleration.
- C It remains stationary at first and then accelerates forwards with an increasing acceleration.
- D It moves forwards immediately with a constant velocity.
- E It remains stationary at first and then moves forwards with a constant velocity.

PART E Advanced Mathematics and Advanced Physics

**79** For any real numbers  $a$ ,  $b$  and  $c$  where  $a \geq b$ , consider these three statements:

**1**  $-b \geq -a$

**2**  $a^2 + b^2 \geq 2ab$

**3**  $ac \geq bc$

Which of the above statements must be true?

**A** none of them

**B** 1 only

**C** 2 only

**D** 3 only

**E** 1 and 2 only

**F** 1 and 3 only

**G** 2 and 3 only

**H** 1, 2 and 3

**80** A white billiard ball of mass  $0.20 \text{ kg}$  is travelling horizontally at  $3.0 \text{ m s}^{-1}$  and hits a red billiard ball of the same mass which is at rest. After the collision the white ball continues in the same direction with a speed of  $1.0 \text{ m s}^{-1}$ .

What is the speed of the red ball immediately after the collision?

**A**  $1.0 \text{ m s}^{-1}$

**B**  $1.5 \text{ m s}^{-1}$

**C**  $2.0 \text{ m s}^{-1}$

**D**  $2.5 \text{ m s}^{-1}$

**E**  $3.0 \text{ m s}^{-1}$

- 81 The sequence  $a_n$  is given by the rule:

$$a_1 = 2$$
$$a_{n+1} = a_n + (-1)^n \text{ for } n \geq 1$$

What is  $\sum_{n=1}^{100} a_n$

- A 150
- B 250
- C -4750
- D 5150
- E  $4\left(1 - \left(\frac{1}{2}\right)^{100}\right)$
- F  $4\left(\left(\frac{3}{2}\right)^{100} - 1\right)$
- 82 A ball is dropped from a height of 16 m on to a horizontal surface, and on each bounce loses 50% of its kinetic energy.
- After which bounce will the maximum height of the rebound fall to less than 160 cm for the first time?
- (Assume air resistance is negligible, and the only external force acting on the ball while not in contact with the surface is gravity.)
- A 4<sup>th</sup>
- B 5<sup>th</sup>
- C 6<sup>th</sup>
- D 7<sup>th</sup>
- E 8<sup>th</sup>

83 How many real roots does the equation  $x^4 - 4x^3 + 4x^2 - 10 = 0$  have?

- A 0
- B 1
- C 2
- D 3
- E 4

84 A man of weight 600 N stands on a set of accurate weighing scales in a moving elevator (lift). The reading on the scales is 480 N.

Which statement correctly describes the motion of the elevator?

- A The elevator is moving downwards with constant speed.
- B The elevator is moving downwards with decreasing speed.
- C The elevator is moving upwards with increasing speed.
- D The elevator is moving upwards with constant speed.
- E The elevator is moving upwards with decreasing speed.

85 The variables  $x$  and  $y$  and the constants  $a$  and  $b$  are real and positive. The variables  $x$  and  $y$  are related.

A graph of  $\log y$  against  $\log x$  is drawn.

For which one of the following relationships will this graph be a straight line?

- A  $y^6 = a^x$
- B  $y = ab^x$
- C  $y^2 = a + x^b$
- D  $y = ax^b$
- E  $y^x = a^b$

- 86** The track for a tram is straight and horizontal. A tram is travelling along the track at a velocity of  $12.0 \text{ m s}^{-1}$  when the brakes are applied. Because of this, the tram decelerates to rest at a constant rate of  $1.50 \text{ m s}^{-2}$ .

What is the distance travelled by the tram over the total time for which it is decelerating?

- A** 18.0 m
- B** 48.0 m
- C** 96.0 m
- D** 108 m
- E** 216 m

- 87** For what values of the non-zero real number  $a$  does the quadratic equation

$$ax^2 + (a - 2)x = 2$$

have distinct real roots?

- A** all values of  $a$
  - B**  $a = -2$
  - C**  $a > -2$
  - D**  $a \neq -2$
  - E** no values of  $a$
- 88** A particle of weight 5 N is held in position by two light ropes.

One of the ropes makes an angle of  $60^\circ$  with the upward vertical, the other is horizontal.

What is the tension in the horizontal rope?

- A**  $1.25\sqrt{3} \text{ N}$
- B** 5 N
- C**  $5\sqrt{3} \text{ N}$
- D** 10 N
- E**  $10\sqrt{3} \text{ N}$

PART E Advanced Mathematics and Advanced Physics

- 89 The angle  $x$  is measured in radians and is such that  $0 \leq x \leq \pi$ .

The total length of any intervals for which  $-1 \leq \tan x \leq 1$  and  $\sin 2x \geq 0.5$  is

- A  $\frac{\pi}{12}$
- B  $\frac{\pi}{6}$
- C  $\frac{\pi}{4}$
- D  $\frac{\pi}{3}$
- E  $\frac{5\pi}{12}$
- F  $\frac{\pi}{2}$
- G  $\frac{5\pi}{6}$

- 90 A train consists of a powered engine travelling horizontally pulling two unpowered carriages.

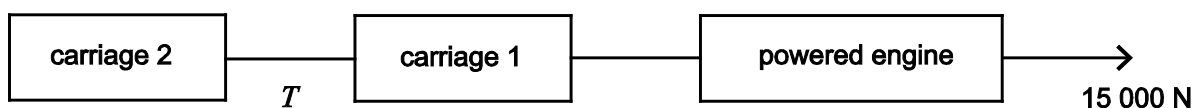

The engine has a mass of 20 000 kg, and each carriage has a mass of 5000 kg. When the engine accelerates from rest it develops a thrust (driving force) of 15 000 N as shown.

Ignoring resistive forces, what is the tension (pulling force)  $T$  in the light and inextensible coupling between carriage 1 and carriage 2?

- A 2500 N
- B 3750 N
- C 5000 N
- D 7500 N
- E 15000 N

**END OF TEST**

**BLANK PAGE**

